





Ecolabel (35°C / 55°C)		<b>A++ / A+</b>		Ecolabel (35°C / 55°C)	
Binnenunit	Type	<b>WCD10</b>		Type	Unité intérieure
	Fabriekscode	WGHA100DG		Code de fabrication	
Buitenunit	Type	<b>WOC10RIY</b>		Type	Unité extérieure
	Fabriekscode	WOHA100LFTA		Code de fabrication	
Koelmiddel		R410A			Réfrigérant
Verwarming (*)	Vermogen +7°C/35°C	kW	10	kW	Puissance +7°C/35°C
	Opgen. elektr. vermogen	kW	2,49	kW	Puissance él. absorbée
	COP		4,02		COP
	Vermogen +2°C/35°C	kW	2,78	kW	Puissance +2°C/35°C
	Opgen. elektr. vermogen	kW	0,68		Puissance él. absorbée
	COP		4,08		COP
	Vermogen +7°C/45°C	kW	8,27		Puissance +7°C/45°C
	Opgen. elektr. vermogen	kW	2,53	kW	Puissance él. absorbée
	COP		3,27		COP
	Vloeistof injectie		-		Injection Liquide
Verwarming Max. vermogen	Vermogen -10°C/35°C	kW	7,33	kW	Puissance-10°C/35°C
	Vermogen -10°C/45°C	kW	7,06	kW	Puissance-10°C/45°C
	Vermogen -10°C/60°C	kW	-	kW	Puissance-10°C/60°C
	Vermogen -15°C/35°C	kW	7,20	kW	Puissance-15°C/35°C
	Vermogen -15°C/45°C	kW	6,50	kW	Puissance-15°C/45°C
	Vermogen -15°C/60°C	kW	-	kW	Puissance-15°C/60°C
Koeling			optie/option		Refroidissement
Binnendeel	Waterdebiet nominaal	l/u	1730	l/h	Débit d'eau nominal
	Waterdebiet minimaal	l/u	1080	l/h	Débit d'eau minimal
	Werkdruk maximaal	Bar	3	Bar	Pression opérationnelle max.
	Wateruitrede min-max	°C	+8/+55	°C	Sortie d'eau min./max.
	Waterinhoud	L	16	L	Contenu eau
	Expansievat	L	12	L	Vase d'expansion
	Waterinhoud vat SWW	L	190	L	Contenu boiler ECS
	Elektr. bijverwarming SWW	kW	0,7	kW	Chauffage aux. ECS
	Isolatie boiler		5cm Neopor		Isolation boiler
	Oppervlakte wisselaar boiler	m <sup>2</sup>	1,7	m <sup>2</sup>	Surface échangeur boiler
	Hoogte-breedte-lengte	mm	1840-648-698	mm	Hauteur-largeur-profondeur
	Gewicht (leeg-gevuld)	kg	152/366	kg	Poids (vide-plein)
Kleur	RAL	9003	RAL	Couleur	
Buitendeel	Geluidsniveau	dB(A)	54	dB(A)	Niveau sonore
	Debiet (hoog)	m <sup>3</sup> /h	3600	m <sup>3</sup> /h	Débit (haut)
	Compressor		DC Twin Rotary		Compresseur
	Werkingslim. verwarmen	°C	-20/+35	°C	Plage de fonct. chauff.
	Hoogte-breedte-lengte	mm	830-900-330	mm	Hauteur/largeur/profond.
	Gewicht	kg	60	kg	Poids
	Kleur (benadering)	RAL	1013	RAL	Couleur (approximative)
Elektr. install.	Voeding	V	230/1	V	Alimentation
	Stroom max. verwarmen	A	18,5	A	Amp. max chauffage
	Zekering traag	A	20	A	Fusible retardé
	Hoofdvoeding aanbr.op		buiten/ext.		Unité à alimenter
	Sectie voedingskabel	mm <sup>2</sup>	3G2,5	mm <sup>2</sup>	Section câble alimentation
	Sectie tssn bi en bu	mm <sup>2</sup>	4G1,5	mm <sup>2</sup>	Section entre int. et ext.
	Voeding SWW	V	230/1	V	Alimentation ch. aux. ECS
Zekering SWW	A	10	A	Fusible ECS ch. aux.	
Sectie SWW	mm <sup>2</sup>	1,5	mm <sup>2</sup>	Section ch. aux. ECS	
Tech. install.	Hydr. aansluiting binnendeel	inch	1"	inch	Raccordement hydraulique
	Diameter hoofdleiding	inch	1"	inch	Diamètre tuyau principal
	Expansie		buiten/ext.		Détente
	Zuigleiding bi/bu	inch	5/8	inch	Diamètre gaz int/ext
	Vloeistofleiding bi/bu	inch	3/8	inch	Diamètre liquide int/ext
	Standaardvulling (CO <sub>2</sub> -eq)**	kg-m (kg)	1,8-15 (3758)	kg-m (kg)	Charge standard (CO <sub>2</sub> -eq)**
	Bijvulling (CO <sub>2</sub> -eq)**	g/m (kg)	40 (84)	g/m (kg)	Charge supplémentaire (CO <sub>2</sub> -eq)**
	Min./Max. leidinglengte	m	5-30	m	Longueur min./max. tuyaux
	Hoogteverschil max	m	20	m	Dénivelé max
Diam. condensafvoer bi/bu	mm	32/16	mm	Diam. évac. condensat bi/bu	

(\*) gegevens volgens de norm EN14511

(\*\*) Gerekend met een GWP-waarde van 2088 voor R410a

(\*) suivant la norme EN14511

(\*\*) Calculé avec une GWP-valeur de 2088 pour R410a

Binnendeel

Unité intérieure

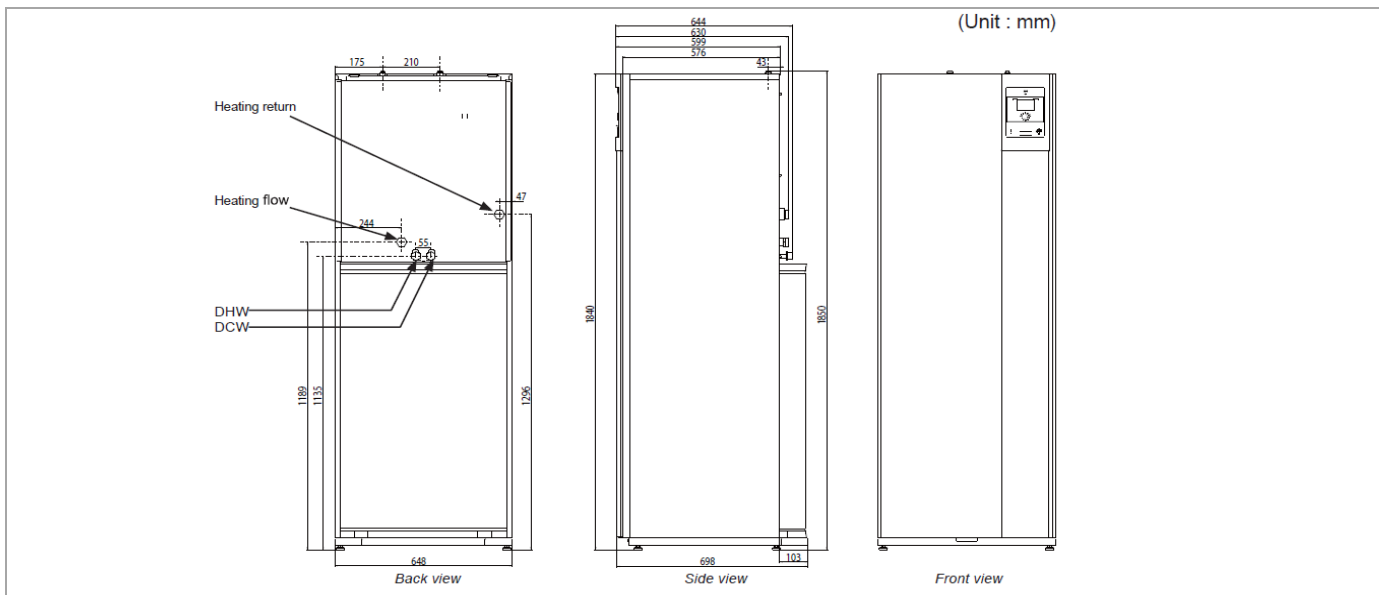

Buitendeel

Unité extérieure

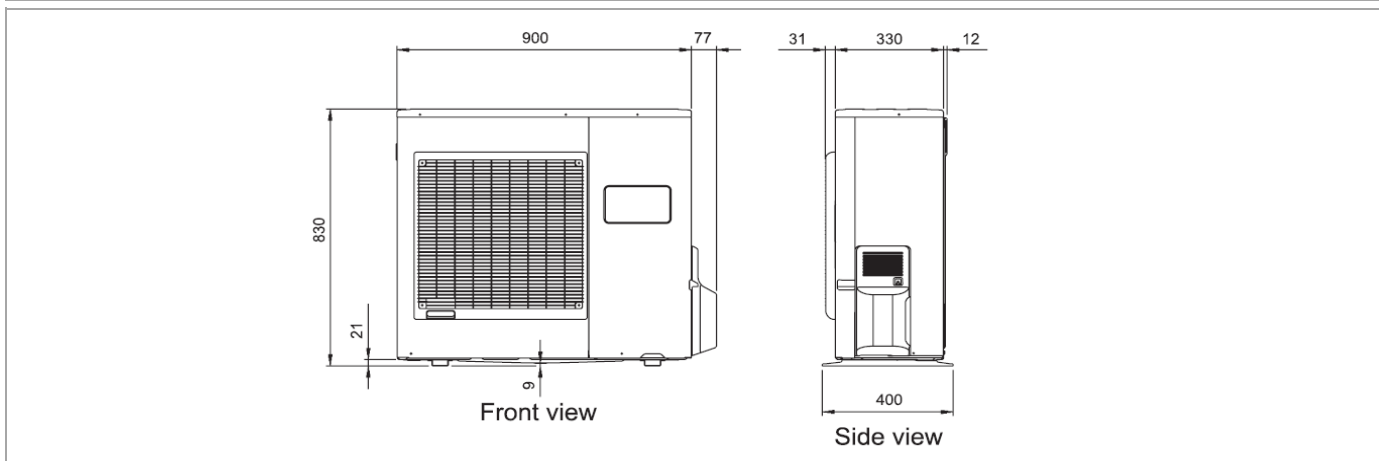

Montage

Montage

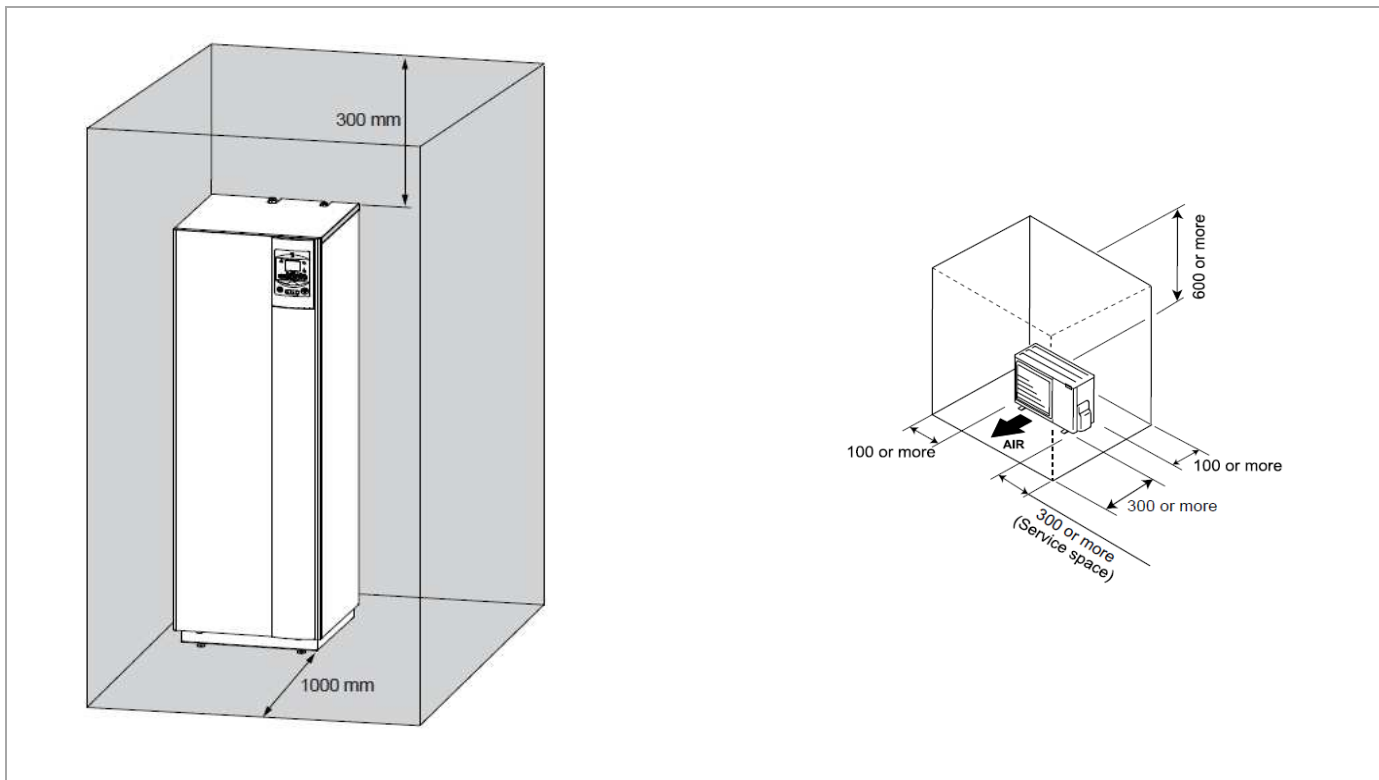

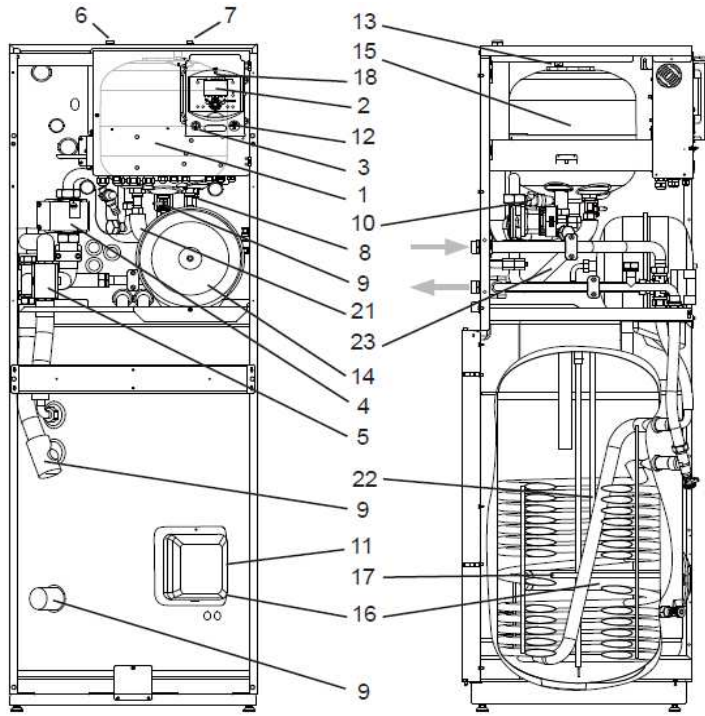





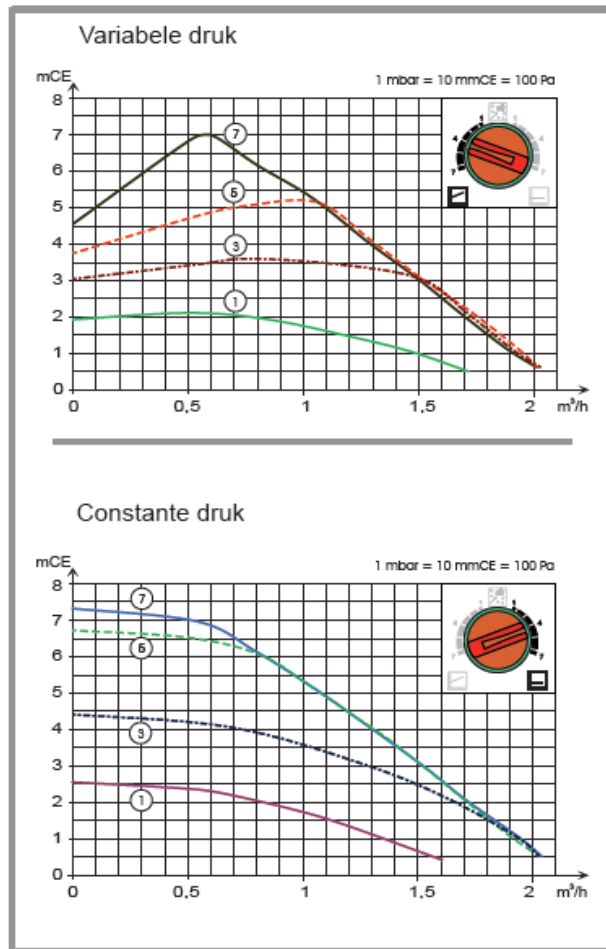

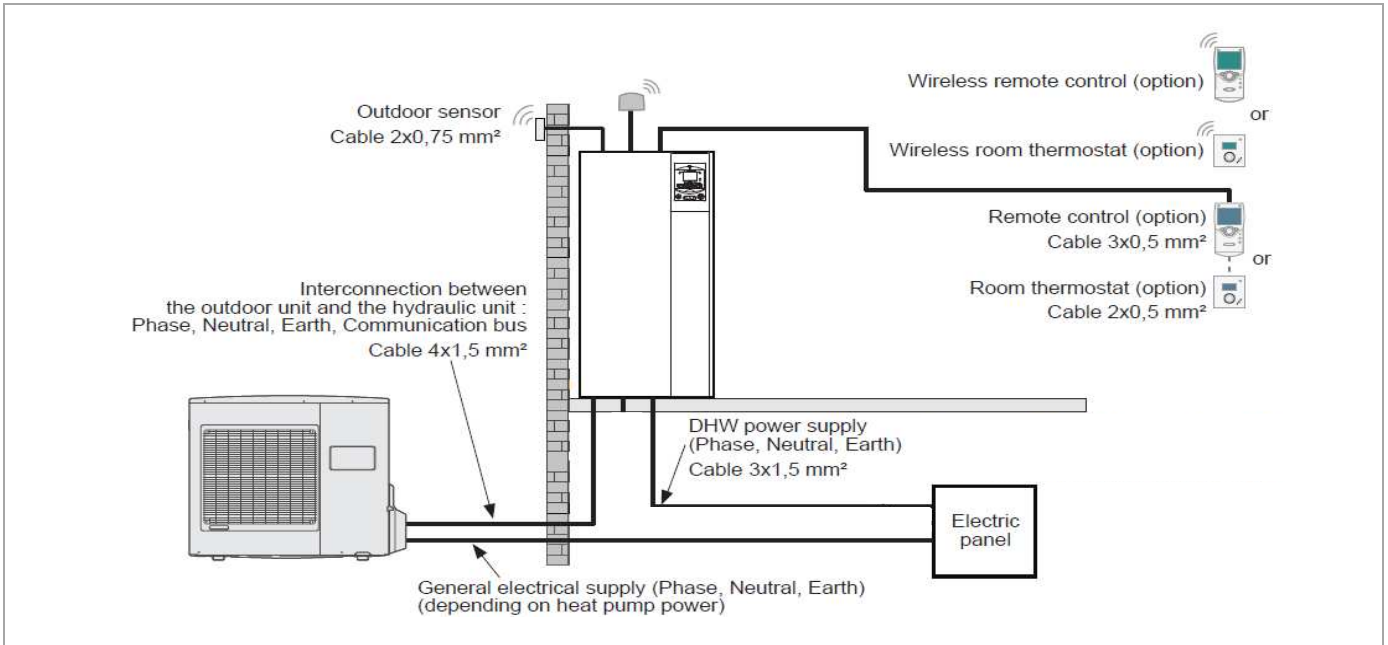
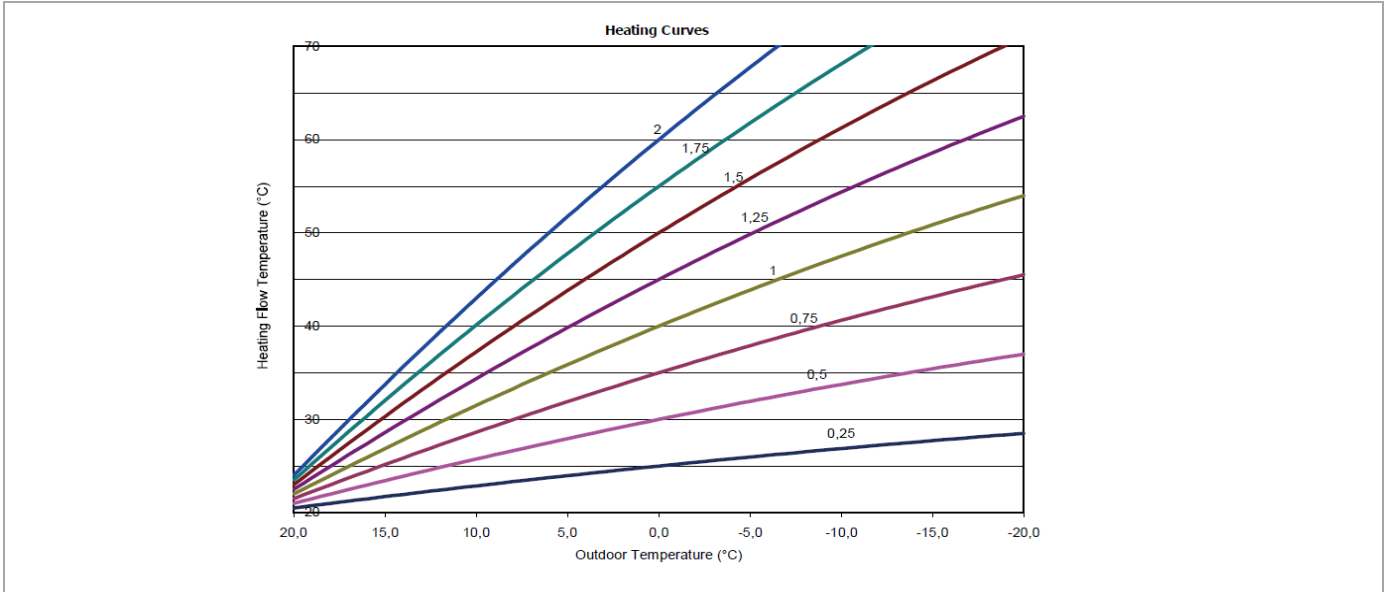

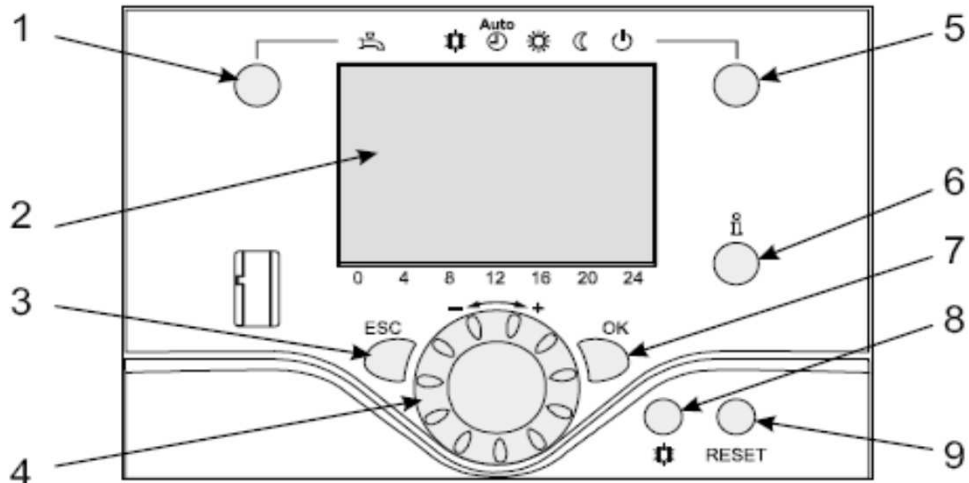

*Legend :*

- 1 - Electric box.
  - 2 - Regulator / User interface.
  - 3 - Start/stop switch.
  - 4 - Hydraulic pumping unit.
  - 5 - Distribution valve.
  - 6 - Gas refrigeration connection.
  - 7 - Liquid refrigeration connection.
  - 8 - Condensation sensor.
  - 9 - Drain valve.
  - 10 - Safety valve.
  - 11 - Safety thermostat.
  - 12 - Manometer.
  - 13 - Manual drainer.
  - 14 - Expansion vessel.
  - 15 - Condenser.
  - 16 - Electrical back-ups DHW (Soapstone).
  - 17 - ACI.
  - 18 - ACI card.
- Sensors :*
- 21 - Water flow sensor.
  - 22 - DHW sensor.
  - 23 - Water return sensor.







Ref.	Function	- Definitions
1	Selection of the DHW operating regime (Domestic hot water)	- If the installation is fitted with a DHW tank.  - ON: Production of DHW according to the time program. - Off: Preparing the domestic hot water for stopping with the anti-frost function active. - Boost: Hold down the DHW key for 3 seconds. Immediate DHW operation after use of the electrical back-ups until the DHW comfort setting has been reached
	 ON  Off	
2	Digital display	- Operating control. Readout of the current temperature, of the heating regime and of any faults  . - View the settings
3	Exit "ESC"	- Quit the menu.
4	Navigation and setting	- Selecting the menu. - Setting parameters. - Adjusting the ambient temperature setpoint.
5	Selecting the heating regime	-  Heating operating according to the heating programme (Summer/winter mode switchover is automatic). -  Constant comfort temperature. -  Constant reduced temperature. -  Stand-by regime with anti-frost protection (Provided that the heat pump's electrical power supply is not interrupted).
6	Information display	- Various data (please see page 59). -  Reading error codes (please see page 57). -  Information concerning maintenance, special regime.
7	Confirm "OK"	- Input into the selected menu. - Confirmation of the parameter settings. - Confirmation of the adjustment to the comfort temp. setting.
8	Selecting cooling mode	- If the installation is fitted with the cooling kit: -  Cooling operating according to the heating programme (Summer/winter mode switchover is automatic).
9	RESET button (Hold down the "RESET" key for 3 seconds).	- Reinitialising the parameters and cancelling error messages. Do not use during normal operation.

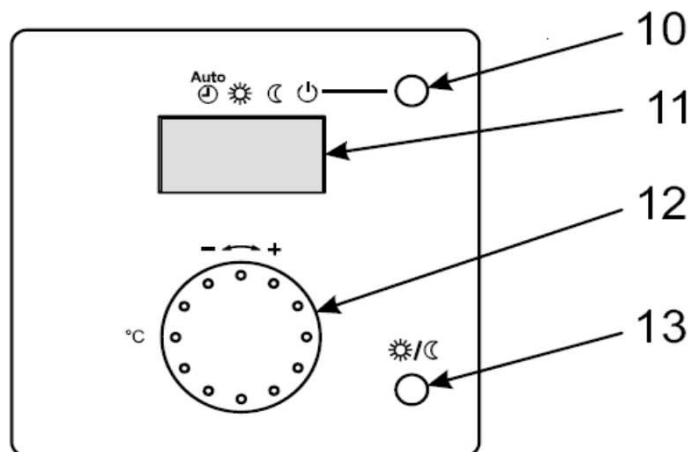

Ref.	Function	- Definitions
10	Selecting the heating regime	<ul style="list-style-type: none"> <li>-  Heating operating according to the heating programme (Summer/winter mode switchover is automatic).</li> <li>-  Constant comfort temperature.</li> <li>-  Constant reduced temperature.</li> <li>-  Stand-by regime with anti-frost protection (Provided that the heat pump's electrical power supply is not interrupted).</li> </ul>
11	Digital display	- Operating control. Readout of the current temperature, of the heating regime and of any faults  .
12	Control knob	- Adjusting the ambient temperature setpoint
13	Presence key	- Comfort / Reduced switchover